

Article number: 50300202

Description: Closed pillow block PM 20 E
FM standard bearing included

Measures

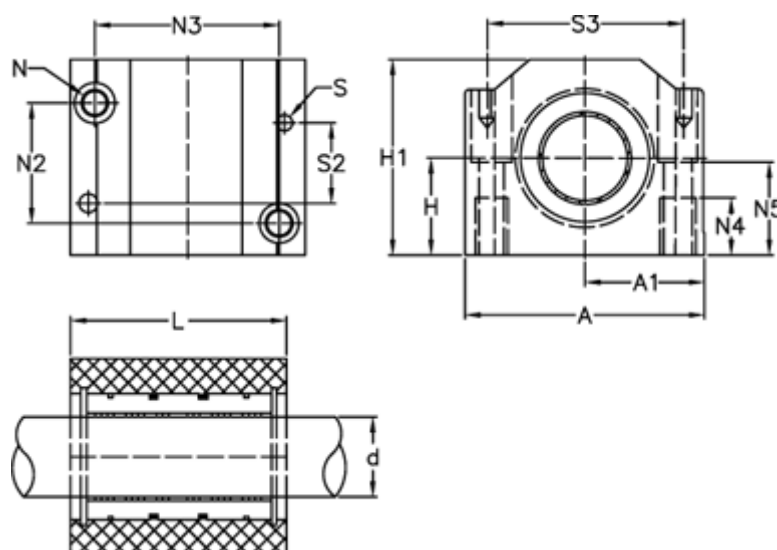

A = 60	N4 = 18
A1 = 30	N5 = 24
H = 25	S = 5
H1 = 50	S2 = 45
L = 54	S3 = 50
N = M8 x 1,25	Static load (kg) = 945
N2 = 32.15	Weight (kg) = 0.329
N3 = 45.15	